

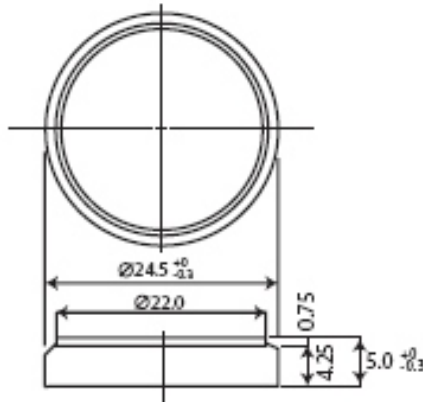

# CR2450

Lithium Manganese Dioxide  
(Li-MnO<sub>2</sub>) Coin Batteries

Dimensions(mm)



Nominal capacity (15KΩ, 2.0V off)	600mAh
Nominal voltage	3.0V
Max. constant current	6mA
Max. pulse current	25mA
Operating temperature	-20~+70°C
Weight	7.0g

## WARNING

- Do not short-circuit between "+" and "-" terminals.
- Do not charge, damage the battery or throw it into fire.
- Do not solder directly on the battery. Please use wire or nickel sheet by spot welding.
- Take out the battery when discharged to cut-off voltage, and dispose of according to the national and local laws.

### 1. TEMPERATURE CHARACTERISTICS

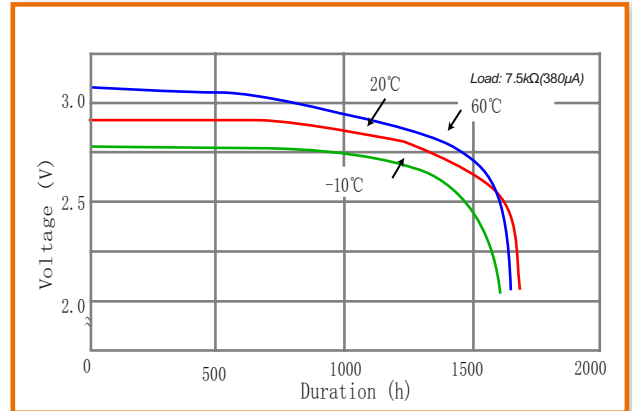

### 2. OPERATING VOLTAGE VS. LOAD RESISTANCE

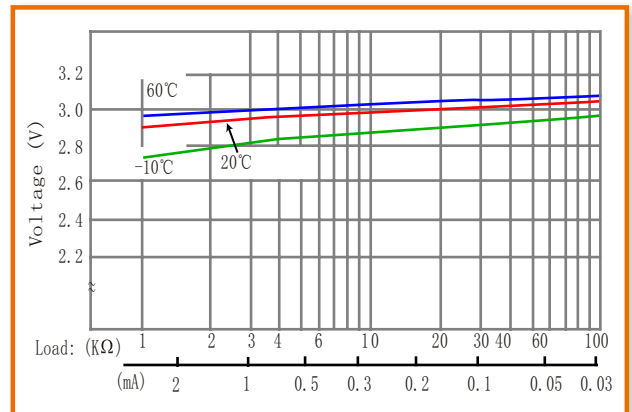

### 3. CAPACITY VS. LOAD RESISTANCE

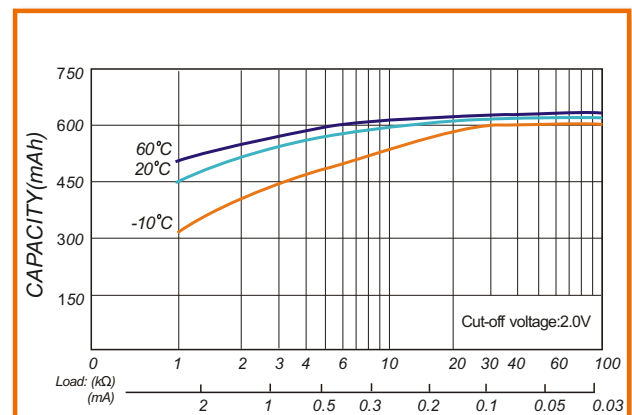

EVE ENERGY CO., LTD.

Address.: EVE Industrial Park, XiKeng Industrial zone, Huihuan Town, Huizhou, Guangdong, China

Operator: (86-752)260 6966

Direct: (86-752)260 5822

Fax: (86-752)260 6033

P.C. 516006

<http://www.evebattery.com>

Email: [sales@evebattery.com](mailto:sales@evebattery.com)

Latest version can be downloaded from the EVE website

CR2450 2010.05